



# STGF35HF60W, STGW35HF60W, STGFW35HF60W

35 A, 600 V Ultrafast IGBT

Datasheet – production data

## Features

- Improved  $E_{off}$  at elevated temperature
- Minimal tail current
- Low conduction losses

## Applications

- Welding
- High frequency converters
- Power factor correction

## Description

This Ultrafast IGBT is developed using a new planar technology to yield a device with tighter switching energy variation ( $E_{off}$ ) versus temperature. The suffix "W" denotes a subset of products designed for high switching frequency operation (over 100 kHz).

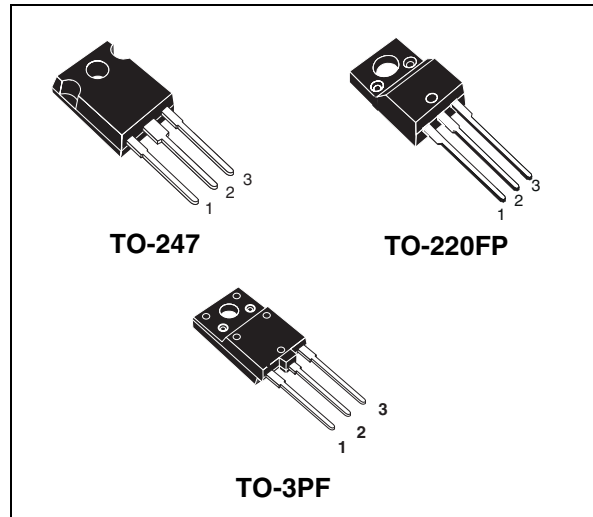

Figure 1. Internal schematic diagram

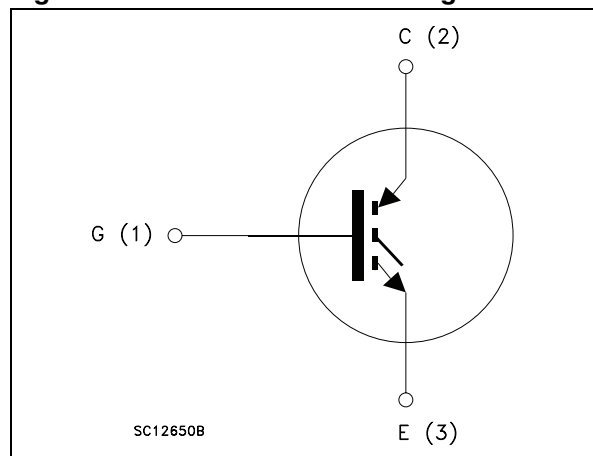

Table 1. Device summary

Order codes	Markings	Packages	Packaging
STGF35HF60W	GF35HF60W	TO-220FP	Tube
STGW35HF60W	GW35HF60W	TO-247	
STGFW35HF60W	GF35HF60W	TO-3PF	

# Contents

<b>1</b>	<b>Electrical ratings</b> .....	<b>3</b>
<b>2</b>	<b>Electrical characteristics</b> .....	<b>4</b>
2.1	Electrical characteristics (curves) .....	6
<b>3</b>	<b>Test circuits</b> .....	<b>9</b>
<b>4</b>	<b>Package mechanical data</b> .....	<b>10</b>
<b>5</b>	<b>Revision history</b> .....	<b>16</b>

# 1 Electrical ratings

**Table 2. Absolute maximum ratings**

Symbol	Parameter	Value			Unit
		TO-247	TO-220FP	TO-3PF	
$V_{CES}$	Collector-emitter voltage ( $V_{GE} = 0$ )	600			V
$I_C$	Continuous collector current at $T_C = 25$ °C	60	19	36	A
$I_C$	Continuous collector current at $T_C = 100$ °C	35	12	18	A
$I_{CP}^{(1)}$	Pulsed collector current	150			A
$I_{CL}^{(2)}$	Turn-off latching current	80			A
$V_{GE}$	Gate-emitter voltage	$\pm 20$			V
$V_{ISO}$	Insulation withstand voltage (RMS) from all three leads to external heat sink ( $t = 1$ s; $T_C = 25$ °C)		2500		V
$P_{TOT}$	Total dissipation at $T_C = 25$ °C	200	40	88	W
$T_{stg}$	Storage temperature	- 55 to 150			°C
$T_J$	Operating junction temperature				

1. Pulse width limited by maximum junction temperature and turn-off within RBSOA

2.  $V_{CLAMP} = 80\% (V_{CES})$ ,  $V_{GE} = 15$  V,  $R_G = 10$   $\Omega$ ,  $T_J = 150$  °C

**Table 3. Thermal data**

Symbol	Parameter	Value			Unit
		TO-247	TO-220FP	TO-3PF	
$R_{thj-case}$	Thermal resistance junction-case	0.63	3.1	1.41	°C/W
$R_{thj-amb}$	Thermal resistance junction-ambient	50	62.5	50	°C/W

## 2 Electrical characteristics

( $T_J = 25\text{ °C}$  unless otherwise specified)

**Table 4. Static**

Symbol	Parameter	Test conditions	Min.	Typ.	Max.	Unit
$V_{(BR)CES}$	Collector-emitter breakdown voltage ( $V_{GE} = 0$ )	$I_C = 1\text{ mA}$	600			V
$V_{CE(sat)}$	Collector-emitter saturation voltage	$V_{GE} = 15\text{ V}, I_C = 20\text{ A}$		2	2.5	V
		$V_{GE} = 15\text{ V}, I_C = 20\text{ A}, T_J = 125\text{ °C}$		1.65		
$V_{GE(th)}$	Gate threshold voltage	$V_{CE} = V_{GE}, I_C = 1\text{ mA}$	3.75		5.75	V
$I_{CES}$	Collector cut-off current ( $V_{GE} = 0$ )	$V_{CE} = 600\text{ V}$			250	$\mu\text{A}$
		$V_{CE} = 600\text{ V}, T_J = 125\text{ °C}$			1	mA
$I_{GES}$	Gate-emitter leakage current ( $V_{CE} = 0$ )	$V_{GE} = \pm 20\text{ V}$			$\pm 100$	nA

**Table 5. Dynamic**

Symbol	Parameter	Test conditions	Min.	Typ.	Max.	Unit
$C_{ies}$	Input capacitance	$V_{CE} = 25\text{ V}, f = 1\text{ MHz}, V_{GE} = 0$	-	2400	-	pF
$C_{oes}$	Output capacitance			235		pF
$C_{res}$	Reverse transfer capacitance			50		pF
$Q_g$	Total gate charge	$V_{CE} = 400\text{ V}, I_C = 20\text{ A},$	-	140	-	nC
$Q_{ge}$	Gate-emitter charge	$V_{GE} = 15\text{ V},$		13		nC
$Q_{gc}$	Gate-collector charge	(see <a href="#">Figure 18</a> )		52		nC

**Table 6. Switching on/off (inductive load)**

Symbol	Parameter	Test conditions	Min.	Typ.	Max.	Unit
$t_{d(on)}$ $t_r$ $(di/dt)_{on}$	Turn-on delay time Current rise time Turn-on current slope	$V_{CC} = 400\text{ V}$ , $I_C = 20\text{ A}$ $R_G = 10\ \Omega$ , $V_{GE} = 15\text{ V}$ , (see <a href="#">Figure 17</a> )	-	30 15 1650	-	ns ns A/ $\mu$ s
$t_{d(on)}$ $t_r$ $(di/dt)_{on}$	Turn-on delay time Current rise time Turn-on current slope	$V_{CC} = 400\text{ V}$ , $I_C = 20\text{ A}$ $R_G = 10\ \Omega$ , $V_{GE} = 15\text{ V}$ , $T_J = 125\text{ }^\circ\text{C}$ (see <a href="#">Figure 17</a> )	-	30 15 1600	-	ns ns A/ $\mu$ s
$t_r(V_{off})$ $t_{d(off)}$ $t_f$	Off voltage rise time Turn-off delay time Current fall time	$V_{CC} = 400\text{ V}$ , $I_C = 20\text{ A}$ , $R_{GE} = 10\ \Omega$ , $V_{GE} = 15\text{ V}$ (see <a href="#">Figure 17</a> )	-	30 175 40	-	ns ns ns
$t_r(V_{off})$ $t_{d(off)}$ $t_f$	Off voltage rise time Turn-off delay time Current fall time	$V_{CC} = 400\text{ V}$ , $I_C = 20\text{ A}$ , $R_{GE} = 10\ \Omega$ , $V_{GE} = 15\text{ V}$ , $T_J = 125\text{ }^\circ\text{C}$ (see <a href="#">Figure 17</a> )	-	50 225 70	-	ns ns ns

**Table 7. Switching energy (inductive load)**

Symbol	Parameter	Test conditions	Min.	Typ.	Max.	Unit
$E_{on}^{(1)}$ $E_{off}$ $E_{ts}$	Turn-on switching losses Turn-off switching losses Total switching losses	$V_{CC} = 400\text{ V}$ , $I_C = 20\text{ A}$ $R_G = 10\ \Omega$ , $V_{GE} = 15\text{ V}$ , (see <a href="#">Figure 19</a> )	-	290 185 475		$\mu$ J $\mu$ J $\mu$ J
$E_{on}^{(1)}$ $E_{off}$ $E_{ts}$	Turn-on switching losses Turn-off switching losses Total switching losses	$V_{CC} = 400\text{ V}$ , $I_C = 20\text{ A}$ $R_G = 10\ \Omega$ , $V_{GE} = 15\text{ V}$ , $T_J = 125\text{ }^\circ\text{C}$ (see <a href="#">Figure 19</a> )	-	420 350 770	530	$\mu$ J $\mu$ J $\mu$ J

1.  $E_{on}$  is the turn-on losses when a typical diode is used in the test circuit in [Figure 19](#). If the IGBT is offered in a package with a co-pak diode, the co-pak diode is used as external diode. IGBTs and diode are at the same temperature (25 °C and 125 °C).  $E_{on}$  includes diode recovery energy.

## 2.1 Electrical characteristics (curves)

Figure 2. Output characteristics

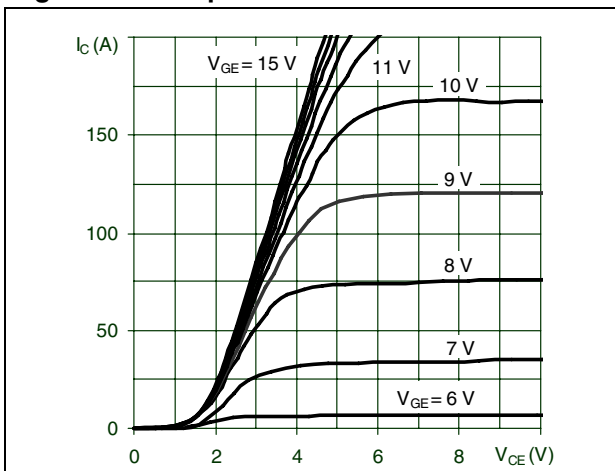

Figure 3. Transfer characteristics

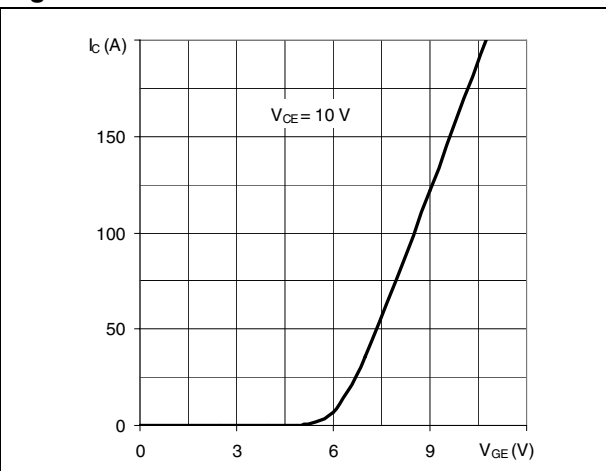

Figure 4. Normalized  $V_{CE(sat)}$  vs.  $I_C$

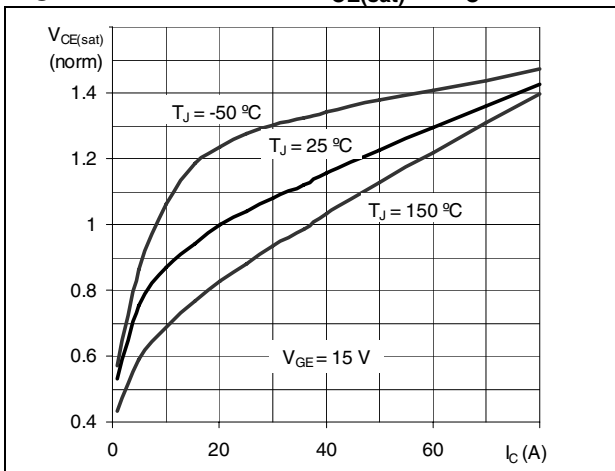

Figure 5. Normalized  $V_{CE(sat)}$  vs. temperature

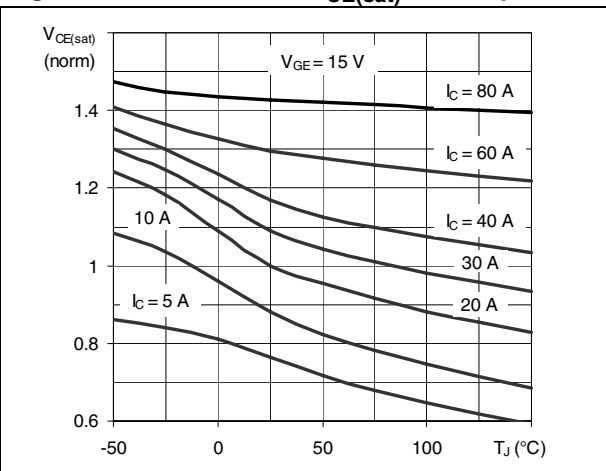

Figure 6. Normalized breakdown voltage vs. temperature

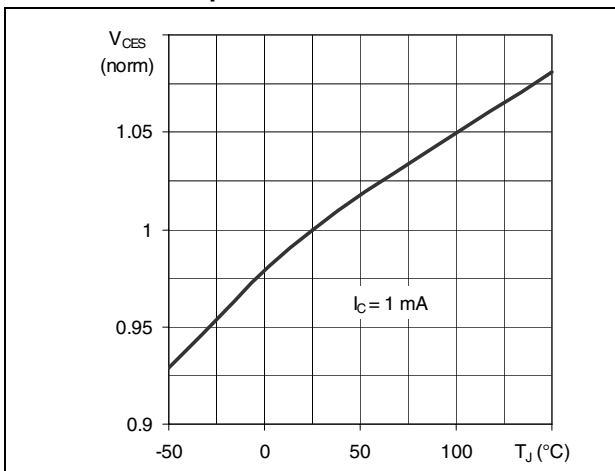

Figure 7. Normalized gate threshold voltage vs. temperature

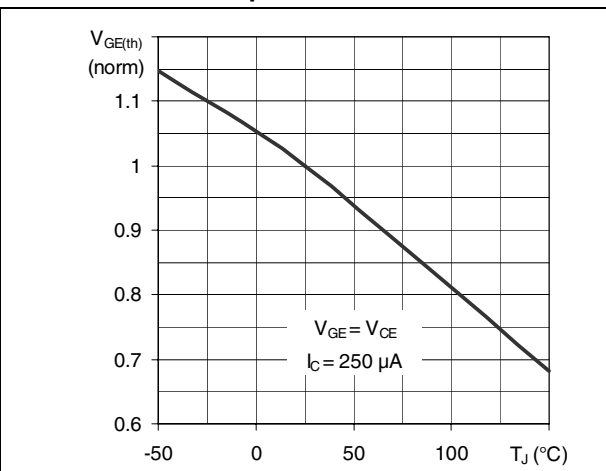

Figure 8. Gate charge vs. gate-emitter voltage

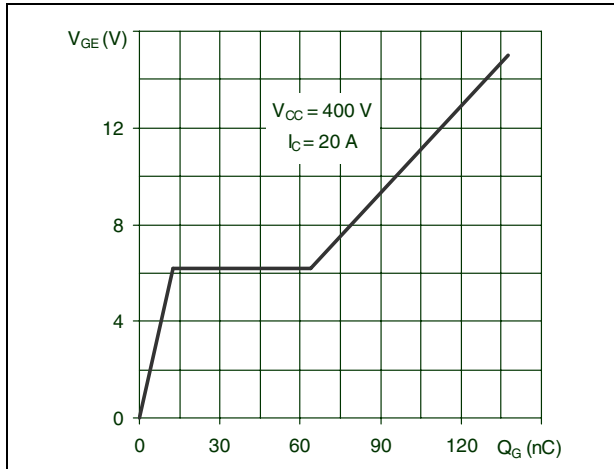

Figure 9. Capacitance variations

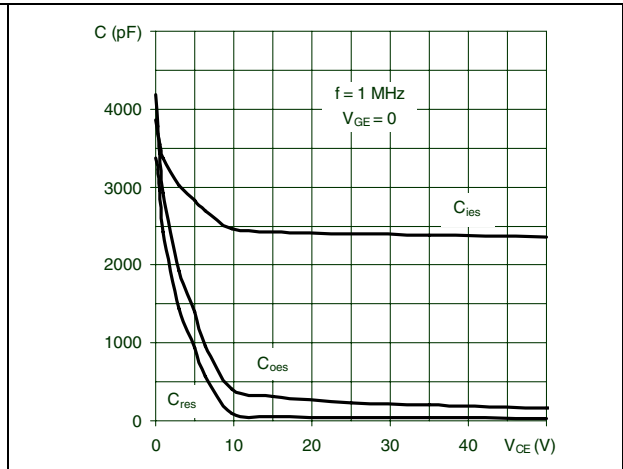

Figure 10. Switching losses vs. temperature

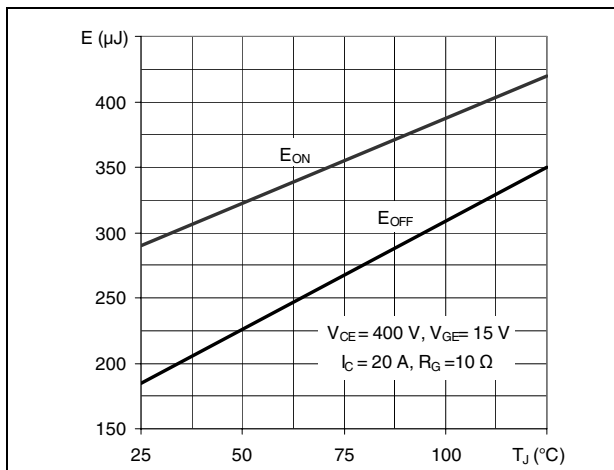

Figure 11. Switching losses vs. gate resistance

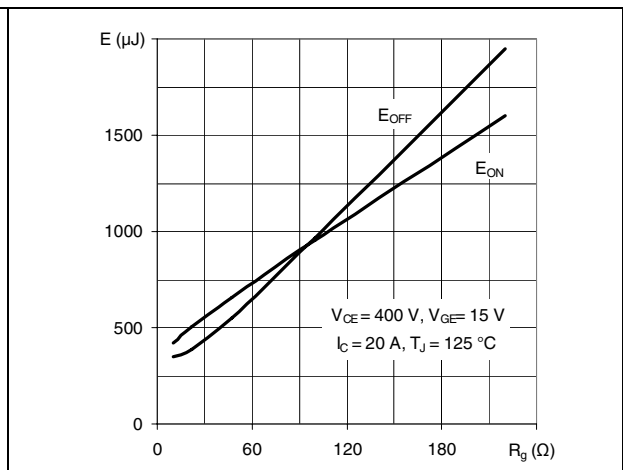

Figure 12. Switching losses vs. collector current

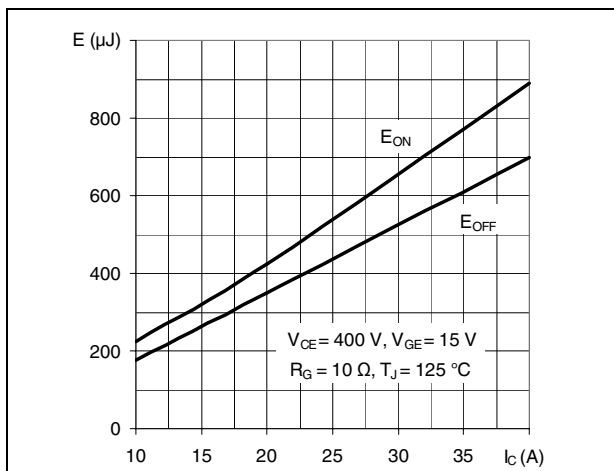

Figure 13. Turn-off SOA

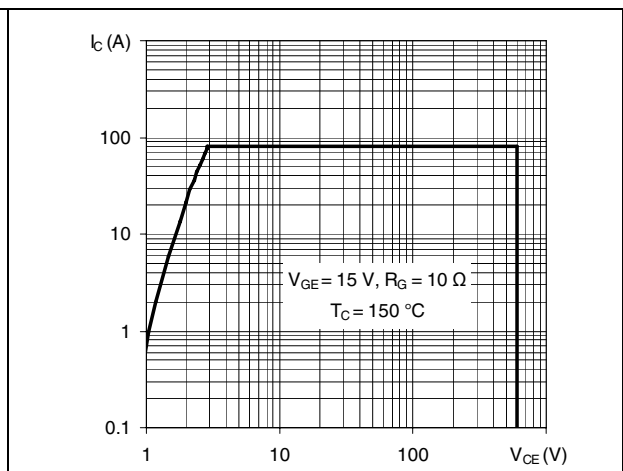

Figure 14. Thermal impedance for TO-247

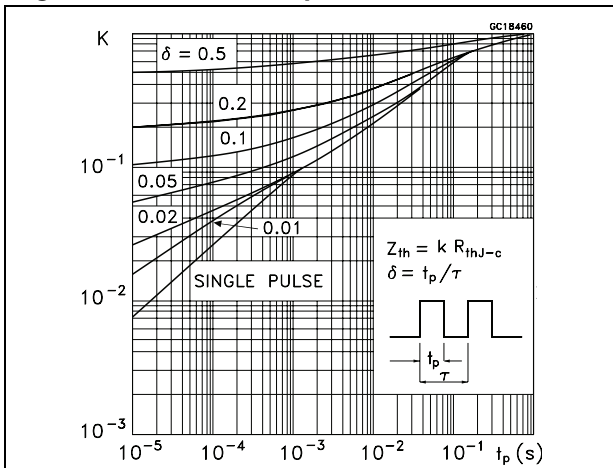

Figure 15. Thermal impedance for TO-220FP

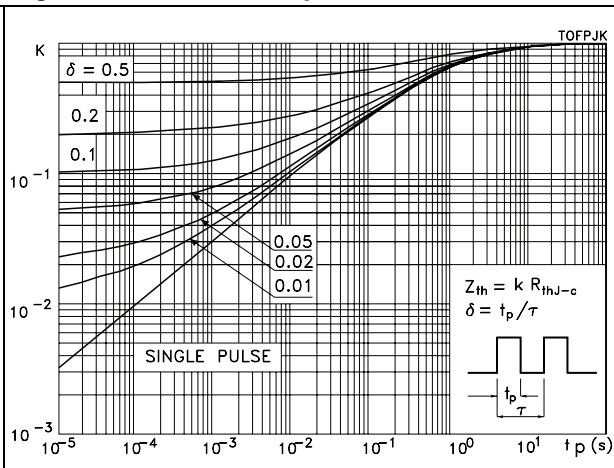
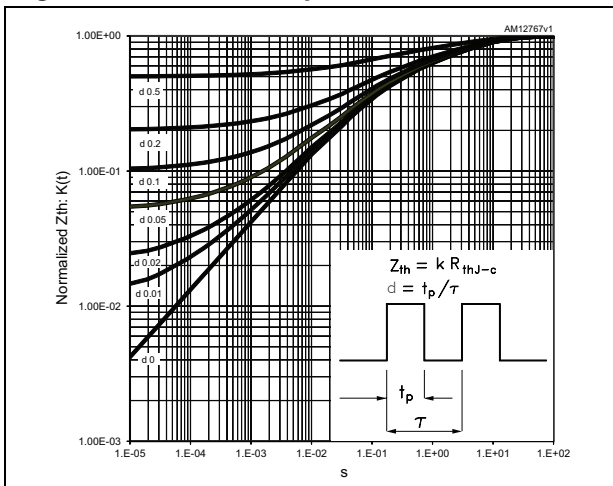

Figure 16. Thermal impedance for TO-3PF







## 4 Package mechanical data

In order to meet environmental requirements, ST offers these devices in different grades of ECOPACK<sup>®</sup> packages, depending on their level of environmental compliance. ECOPACK<sup>®</sup> specifications, grade definitions and product status are available at: [www.st.com](http://www.st.com). ECOPACK<sup>®</sup> is an ST trademark.

**Table 8. TO-220FP mechanical data**

Dim.	mm		
	Min.	Typ.	Max.
A	4.4		4.6
B	2.5		2.7
D	2.5		2.75
E	0.45		0.7
F	0.75		1
F1	1.15		1.70
F2	1.15		1.70
G	4.95		5.2
G1	2.4		2.7
H	10		10.4
L2		16	
L3	28.6		30.6
L4	9.8		10.6
L5	2.9		3.6
L6	15.9		16.4
L7	9		9.3
Dia	3		3.2

Figure 20. TO-220FP drawing

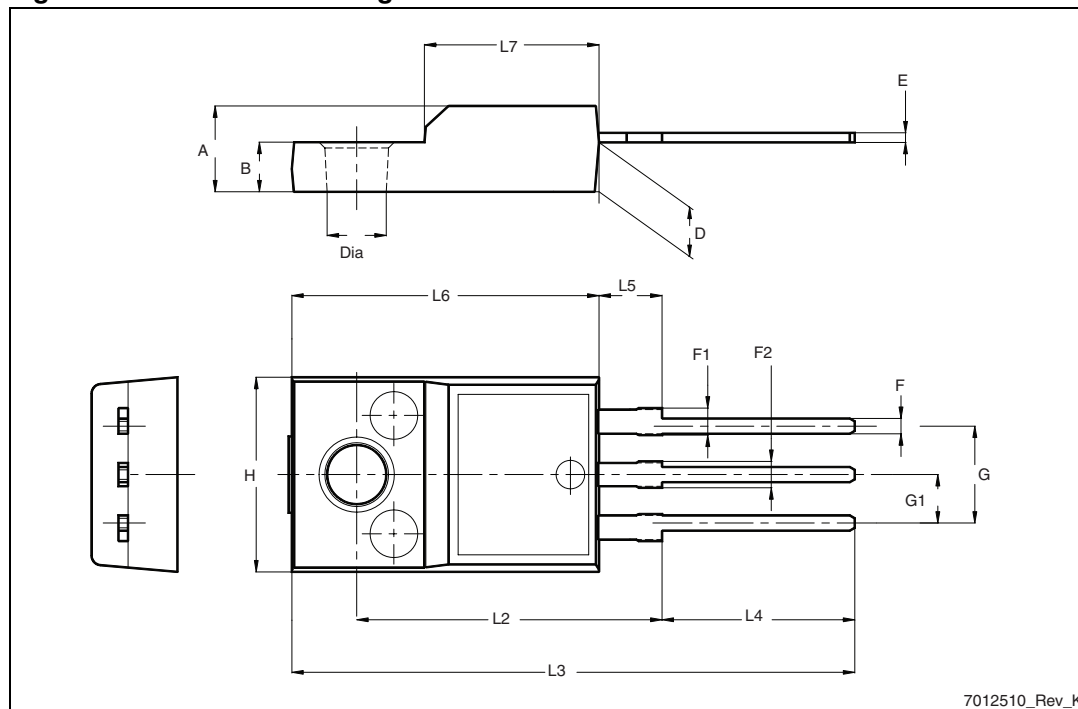

Table 9. TO-247 mechanical data

Dim.	mm		
	Min.	Typ.	Max.
A	4.85		5.15
A1	2.20		2.60
b	1.0		1.40
b1	2.0		2.40
b2	3.0		3.40
c	0.40		0.80
D	19.85		20.15
E	15.45		15.75
e		5.45	
L	14.20		14.80
L1	3.70		4.30
L2		18.50	
ØP	3.55		3.65
ØR	4.50		5.50
S		5.50	

Figure 21. TO-247 drawing

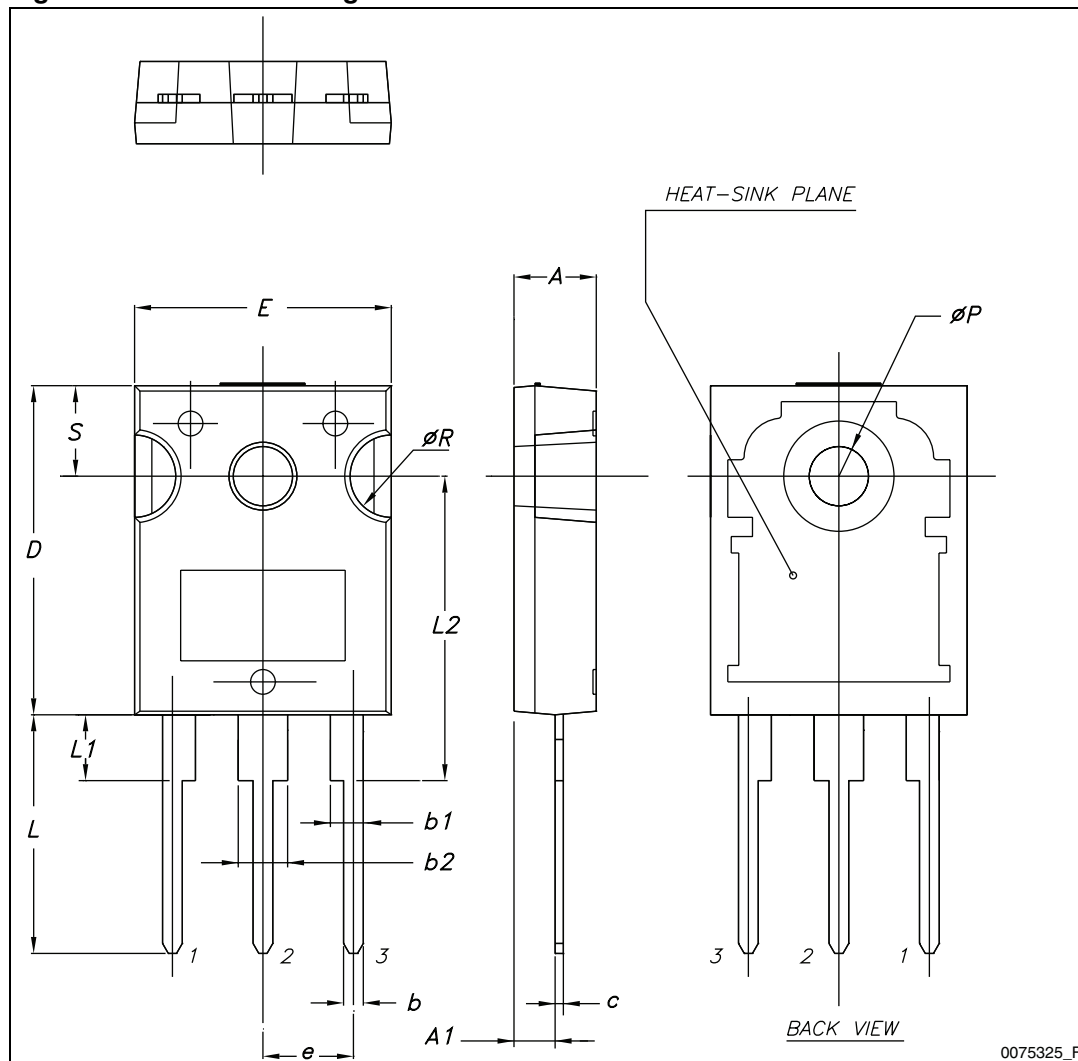
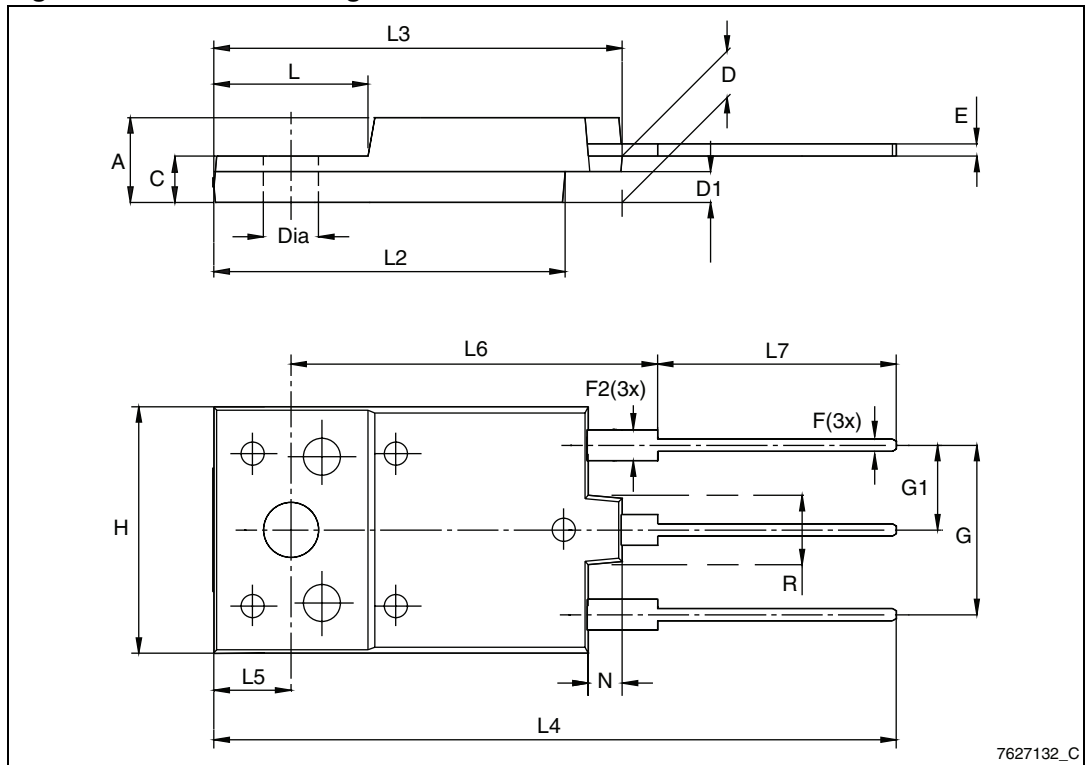

Table 10. TO-3PF mechanical data

Dim.	mm		
	Min.	Typ.	Max.
A	5.30		5.70
C	2.80		3.20
D	3.10		3.50
D1	1.80		2.20
E	0.80		1.10
F	0.65		0.95
F2	1.80		2.20
G	10.30		11.50
G1		5.45	
H	15.30		15.70
L	9.80	10	10.20
L2	22.80		23.20
L3	26.30		26.70
L4	43.20		44.40
L5	4.30		4.70
L6	24.30		24.70
L7	14.60		15
N	1.80		2.20
R	3.80		4.20
Dia	3.40		3.80

Figure 22. TO-3PF drawing



7627132\_C

## 5 Revision history

**Table 11. Document revision history**

<b>Date</b>	<b>Revision</b>	<b>Changes</b>
17-May-2010	1	Initial release.
14-Dec-2010	2	Document status promoted from preliminary data to datasheet. Inserted new order code STGF35HF60W in TO-220FP package.
24-Jul-2012	3	Inserted new order code STGFW35HF60W in TO-3PF package.



**Please Read Carefully:**

Information in this document is provided solely in connection with ST products. STMicroelectronics NV and its subsidiaries ("ST") reserve the right to make changes, corrections, modifications or improvements, to this document, and the products and services described herein at any time, without notice.

All ST products are sold pursuant to ST's terms and conditions of sale.

Purchasers are solely responsible for the choice, selection and use of the ST products and services described herein, and ST assumes no liability whatsoever relating to the choice, selection or use of the ST products and services described herein.

No license, express or implied, by estoppel or otherwise, to any intellectual property rights is granted under this document. If any part of this document refers to any third party products or services it shall not be deemed a license grant by ST for the use of such third party products or services, or any intellectual property contained therein or considered as a warranty covering the use in any manner whatsoever of such third party products or services or any intellectual property contained therein.

**UNLESS OTHERWISE SET FORTH IN ST'S TERMS AND CONDITIONS OF SALE ST DISCLAIMS ANY EXPRESS OR IMPLIED WARRANTY WITH RESPECT TO THE USE AND/OR SALE OF ST PRODUCTS INCLUDING WITHOUT LIMITATION IMPLIED WARRANTIES OF MERCHANTABILITY, FITNESS FOR A PARTICULAR PURPOSE (AND THEIR EQUIVALENTS UNDER THE LAWS OF ANY JURISDICTION), OR INFRINGEMENT OF ANY PATENT, COPYRIGHT OR OTHER INTELLECTUAL PROPERTY RIGHT.**

**UNLESS EXPRESSLY APPROVED IN WRITING BY TWO AUTHORIZED ST REPRESENTATIVES, ST PRODUCTS ARE NOT RECOMMENDED, AUTHORIZED OR WARRANTED FOR USE IN MILITARY, AIR CRAFT, SPACE, LIFE SAVING, OR LIFE SUSTAINING APPLICATIONS, NOR IN PRODUCTS OR SYSTEMS WHERE FAILURE OR MALFUNCTION MAY RESULT IN PERSONAL INJURY, DEATH, OR SEVERE PROPERTY OR ENVIRONMENTAL DAMAGE. ST PRODUCTS WHICH ARE NOT SPECIFIED AS "AUTOMOTIVE GRADE" MAY ONLY BE USED IN AUTOMOTIVE APPLICATIONS AT USER'S OWN RISK.**

Resale of ST products with provisions different from the statements and/or technical features set forth in this document shall immediately void any warranty granted by ST for the ST product or service described herein and shall not create or extend in any manner whatsoever, any liability of ST.

ST and the ST logo are trademarks or registered trademarks of ST in various countries.

Information in this document supersedes and replaces all information previously supplied.

The ST logo is a registered trademark of STMicroelectronics. All other names are the property of their respective owners.

© 2012 STMicroelectronics - All rights reserved

STMicroelectronics group of companies

Australia - Belgium - Brazil - Canada - China - Czech Republic - Finland - France - Germany - Hong Kong - India - Israel - Italy - Japan - Malaysia - Malta - Morocco - Philippines - Singapore - Spain - Sweden - Switzerland - United Kingdom - United States of America

[www.st.com](http://www.st.com)

